

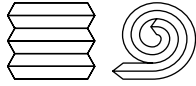

# PERFECTA

PLISSÈ - RULLO



LENDE TECNICHE - INDOOR



## PERFECTA

È una tenda tecnica da interno frizionata con meccanica a rullo o plissettata. L'ampia possibilità di teli oscuranti e filtranti permette l'applicazione in diversi ambienti, abbinandoli al colore dell'infisso.

**ATTENZIONE:** I teli oscuranti non garantiscono un oscuramento totale del 100%.

### COLORI ALLUMINIO



#### RAL STANDARD

-  SEMILUCIDO  
**BIANCO 9010**
-  SEMILUCIDO  
**AVORIO 1013**
-  SEMILUCIDO  
**MARRONE 8017**
-  **TESTA DI MORO SCURO**
-  **ARGENTO OX**

#### LEGNO + 10%

-  **BIANCO FRASSINO**
-  **AVORIO FRASSINO**
-  **GOLDEN OAK**
-  **TERRA**

#### COLORI ACCESSORI

-  **BIANCO**
-  **AVORIO**
-  **GRIGIO**
-  **MARR. C**
-  **NERO**



**GIUNTO A 45°**

**GIUNTO A 90°**



### INSTALLAZIONE

Facile e immediata, per profondità fermavetro fino a 40 mm (ad esclusione di altezze fra 32 e 36mm) si effettua tramite il fissaggio delle apposite clips posizionate tra il vetro e il profilo fermavetro.

Per profondità tra 32 e 36mm e maggiore di 40mm, l'installazione deve essere effettuata tramite apposite viti di fissaggio.

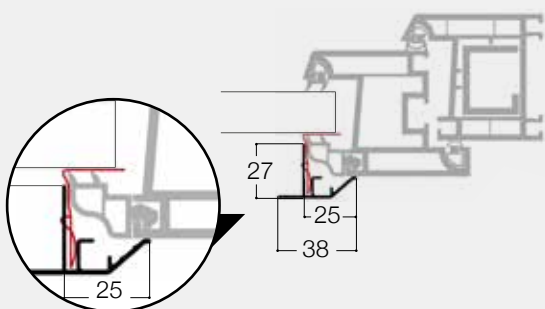

### COME ORDINARE

Le dimensioni di **Perfecta** devono essere trasmesse in millimetri indicando larghezza x altezza e la profondità del fermavetro



(minimo 16 mm).

Perfecta sormonta il fermavetro di 25 mm, pertanto verificare che la posizione della maniglia dell'infisso non interferisca con l'ingombro del prodotto.

### PRODOTTI SPECIALI

Richiedere preventivo in azienda

#### OSCURANTE - FILTRANTE DOUBLE

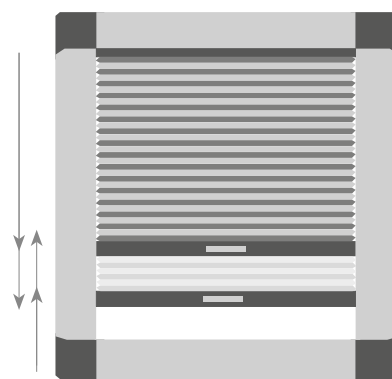

#### REVERSIBILE

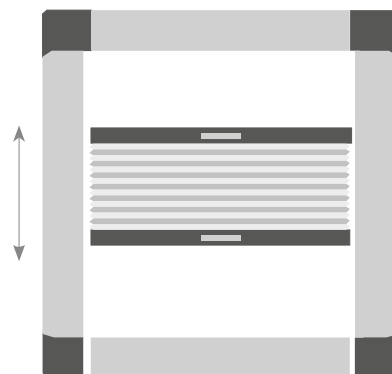

### A RICHIESTA

#### RAL RENOLIT PELLICOLE SKAI PELLICOLE

Per un perfetto abbinamento il colore dei due elementi deve essere identico.

La varietà delle finiture in uso nel mercato impone la soluzione personalizzata del colore; pertanto l'azienda è in grado di offrire la gestione di queste colorazioni personalizzate previo accordo commerciale.



# PERFECTA

PLISSÈ



LENDE TECNICHE - INDOOR



LISTINO IVA ESCLUSA

## PERFECTA - PLISSÈ

Largh.	400	500	600	700	800	900	1000	1100	1200	1300	1400	1500	1600	1700	1800															
400	109	117	122	130	133	144	145	158	158	176	172	190	183	202	194	217	205	231	218	242	228	256	244	277	260	295	267	303	274	310
500	117	129	130	143	143	156	156	176	173	193	186	208	198	223	210	239	223	252	235	267	248	283	266	305	283	329	290	336	297	342
600	127	139	141	154	152	172	171	190	186	210	199	226	212	242	226	260	240	275	254	293	267	308	287	336	307	362	315	370	321	376
700	134	149	149	168	164	185	182	205	198	226	212	244	227	263	242	282	256	297	272	317	287	336	339	364	330	394	371	400	380	408
800	142	157	157	178	175	198	193	221	211	242	227	263	242	283	259	303	274	321	289	341	305	362	344	394	353	426	377	432	385	440
900	151	169	169	190	186	212	204	235	224	260	242	282	260	303	275	325	290	344	308	366	326	386	351	422	378	459	385	466	393	473
1000	158	179	177	202	196	226	217	251	238	277	254	300	273	323	289	344	308	370	328	391	343	414	373	453	400	491	408	497	416	505
1100	169	190	187	215	205	239	228	267	249	294	268	318	288	342	307	366	326	391	343	416	364	440	394	482	426	524	432	531	440	538
1200	177	199	197	227	218	252	240	282	263	310	283	337	303	363	323	387	342	414	363	440	383	468	416	512	449	558	457	564	463	571
1300	186	211	205	239	227	266	251	296	275	328	295	353	317	383	338	410	360	436	381	466	402	492	436	540	473	589	480	597	487	605
1400	193	221	217	249	239	281	263	311	288	343	310	373	332	402	353	431	377	462	399	490	421	519	459	571	495	622	503	629	510	636
1500	200	232	226	263	248	293	274	328	301	360	325	391	347	422	372	453	394	483	418	515	441	545	480	601	519	655	526	661	534	668
1600	210	241	234	274	259	307	286	341	315	377	338	410	363	442	386	474	411	508	435	539	460	572	502	629	-	-	-	-	-	-
1700	219	252	244	286	270	320	297	358	328	394	351	428	377	463	402	495	428	529	454	564	480	598	523	658	-	-	-	-	-	-
1800	227	263	254	297	281	334	310	373	339	411	365	447	393	482	419	517	446	552	473	587	497	624	543	688	-	-	-	-	-	-
1900	235	273	263	310	289	347	321	386	352	428	380	466	407	502	435	539	463	578	490	614	518	650	565	717	-	-	-	-	-	-
2000	244	283	273	321	301	360	332	402	365	443	394	482	422	521	450	561	480	601	509	637	537	677	586	747	-	-	-	-	-	-
2100	251	294	282	334	311	374	343	419	378	462	408	502	436	540	468	582	496	622	526	662	-	-	-	-	-	-	-	-	-	-
2200	260	304	290	344	321	387	358	432	391	477	421	519	453	561	482	605	515	647	545	688	-	-	-	-	-	-	-	-	-	-
Cat.	L	M	L	M	L	M	L	M	L	M	L	M	L	M	L	M	L	M	L	M	L	M	L	M	L	M	L	M	L	M

PREZZI VALIDI PER I COLORI RAL STANDARD, +10% PER I COLORI LEGNO.

# PERFECTA



RULLO

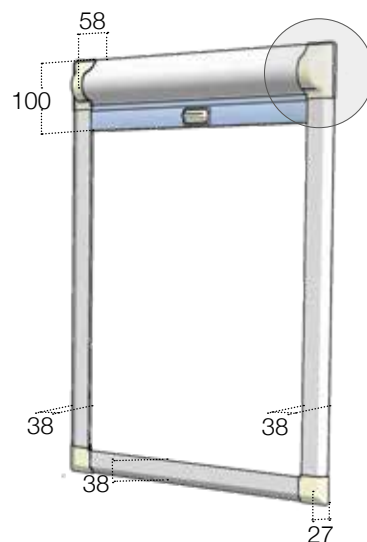

### REGISTRAZIONE MOLLA

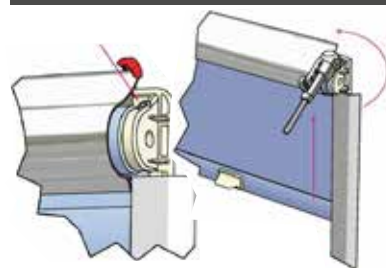

### OPTIONAL

### ASTA DI AZIONAMENTO H200 CM

€ 40,00



TENDE TECNICHE - INDOOR

## PERFECTA - RULLO

Largh.	400			500			600			700			800			900			1000			1100			1200			1300		
400	99	101	117	107	109	133	116	122	147	128	130	162	139	143	179	149	154	193	156	164	197	168	175	221	176	185	238	179	189	244
500	102	107	129	113	117	143	123	129	158	133	139	176	145	152	194	154	163	210	165	175	226	175	185	242	186	193	256	190	199	266
600	109	112	139	118	124	154	129	135	173	141	145	190	154	162	210	163	172	227	175	182	244	183	193	261	193	205	281	198	210	288
700	116	118	149	127	130	168	135	142	186	147	154	204	158	168	226	171	179	244	179	193	265	193	204	283	202	217	300	206	220	308
800	121	127	156	131	136	178	142	150	198	154	162	219	168	177	241	178	189	261	189	200	283	199	212	303	211	226	321	218	232	332
900	128	131	168	136	144	189	149	155	210	158	169	232	175	186	256	186	198	279	197	210	300	206	223	321	219	235	342	226	242	353
1000	131	139	177	143	151	199	154	164	223	168	177	245	179	193	272	193	205	295	205	219	318	218	232	341	228	245	364	233	252	376
1100	136	143	187	149	156	210	162	172	235	175	186	260	189	200	288	199	217	314	212	231	337	226	244	360	238	256	385	244	265	398
1200	142	150	197	154	164	223	168	178	248	179	193	274	196	210	303	206	224	330	220	239	355	233	252	381	244	267	407	251	274	420
1300	149	155	205	162	172	233	175	186	261	187	199	289	202	219	320	217	232	347	228	246	373	241	263	400	254	277	428	260	283	442
1400	154	163	218	168	178	244	179	193	274	193	206	303	210	226	334	223	242	363	238	256	393	249	272	421	263	287	449	270	295	463
1500	157	168	226	173	185	256	187	199	287	199	215	317	218	234	350	231	249	380	244	266	411	256	282	441	270	296	471	279	304	485
1600	164	175	235	178	190	267	193	205	300	205	223	330	223	242	365	239	259	397	252	274	428	266	290	460	281	308	492	287	316	509
1700	172	179	245	185	197	279	198	215	311	215	232	343	232	249	376	245	267	414	260	284	447	274	300	480	288	317	515	295	326	529
1800	176	187	255	193	204	289	205	221	325	220	239	360	239	259	397	252	275	431	267	293	466	283	311	502	296	329	536	304	337	552
1900	-	-	-	197	210	301	211	228	337	227	245	373	244	267	411	261	286	448	275	303	483	290	321	519	305	338	558	314	347	573
2000	-	-	-	-	-	-	219	235	350	234	252	386	252	275	428	268	294	466	283	314	503	297	330	539	315	349	579	321	359	595
Cat.	A	B	C	A	B	C	A	B	C	A	B	C	A	B	C	A	B	C	A	B	C	A	B	C	A	B	C	A	B	C

PREZZI VALIDI PER I COLORI RAL STANDARD, +10% PER I COLORI LEGNO.



# PERFECTA

## PLISSÈ

### FILTRANTI

Listino Tariffa **L**

### OSCURANTI

Listino Tariffa **M**

TENDE TECNICHE - INDOOR

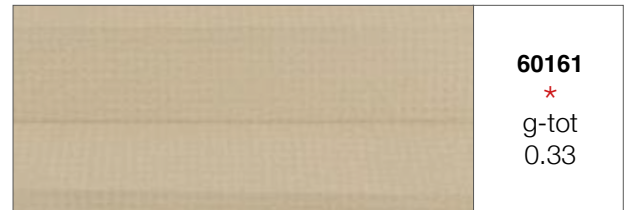
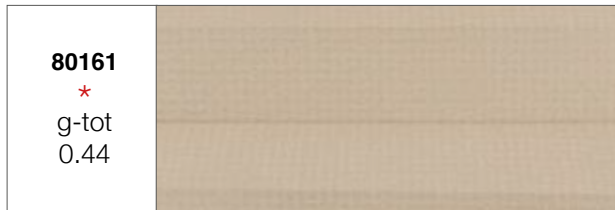

#### FIRE RETARDANT

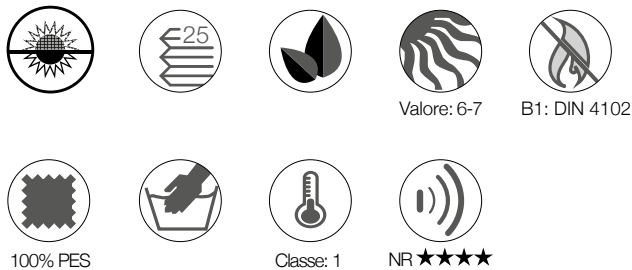

#### FIRE RETARDANT



Gli oscuranti non garantiscono un oscuramento totale in quanto montati su sistema non a tenuta di luce.

**LEGENDA E SIMBOLI**

Filtrante

 Solidità colore  
ISO 105 B02

 Manutenzione:  
Lavabile a mano

Oscurante



Ignifugo

 Classe di confort termico  
UNI EN 14501:2006

 Tessuti cellulari  
per tende plissè

Composizione

 Classe di isolamento  
acustico

 Esente da  
PVC e alogeni

 Manutenzione:  
pulire con panno umido

\* Fattore solare g-tot UNI EN 13363-1:2003 calcolato con vetratura tipo C come da normativa UNI EN 14501:2006



# PERFECTA+NANOBLIND

RULLO



## OSCURANTI

Listino Tariffa



## FILTRANTI

Listino Tariffa



LENDE TECNICHE - INDOOR



100% PES



Classe: 1  
UNI 9177



Classe: 1



Fattore solare g-tot\* UNI EN 13363-1:2003

A001	A007	A018	A019	A025
0.43	0.43	0.43	0.43	0.43

A026	A033	A055	A056	A081
0.43	0.43	0.43	0.43	0.43



100% PES



Classe: 1  
UNI 9177



Classe: 1

Fattore solare g-tot\* UNI EN 13363-1:2003

T401	T403	T404	T405	T406
0.37	0.38	0.44	0.52	0.36

T408	T409	T410	T412
0.41	0.45	0.43	0.40



## FILTRANTI

Listino Tariffa

**B**



100% PES



Classe: 1

Fattore solare g-tot\* UNI EN 13363-1:2003

024
0.39

\* g-tot calcolato con vetratura tipo C come da normativa UNI EN 14501:2006



## FILTRANTI

Listino Tariffa

**C**

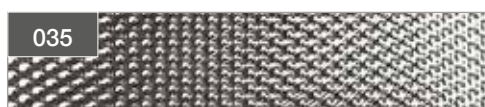

100% PES



Classe: 1

Fattore solare g-tot\* UNI EN 13363-1:2003

033	034	035
0.52	0.33	0.38

### LEGENDA E SIMBOLI

Oscurante



Filtrante Opaco



Filtrante



Filtrante Trasparente



Composizione



Ignifugo



Esente da PVC e alogeni



Manutenzione: pulire con panno umido



Classe di confort termico UNI  
EN 14501:2006



Gli oscuranti non garantiscono un oscuramento totale in quanto montati su sistema non a tenuta di luce.

