

PC 90

PERSIANA A BATTENTE
CON LAMELLE FISSE O ORIENTABILI
EFFETTO TAGLIO A 90°

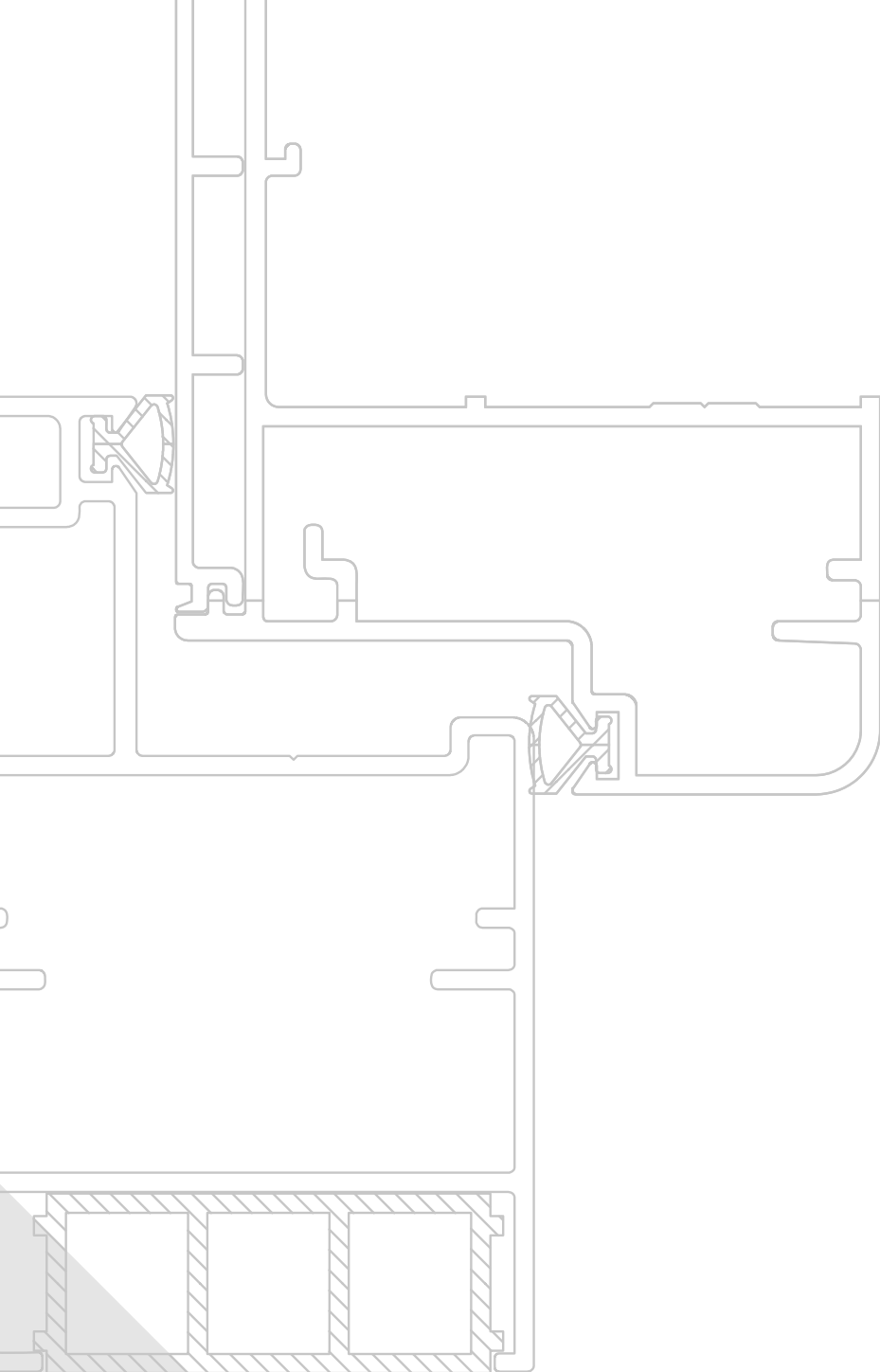













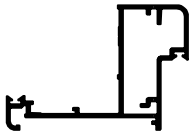

PC 90





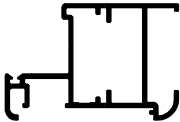

PERSIANA A BATTENTE
CON LAMELLE FISSE O ORIENTABILI
EFFETTO TAGLIO A 90°



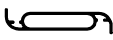

ELENCO PROFILATI

BT 355010 Profilo porta-lamella Butterfly Peso kg/ml. 0.164 Perimetro mm. 105 Super. in vista m ² /m. 0.070 Jx 0.00 cm ⁴ Wx 0.00 cm ³ Jy 00.00 cm ⁴ Wy 0.00 cm ³	 Tavola B 06	PS45.909 Cartella mm.59 Peso kg/ml. 0.291 Perimetro mm. 165 Super. in vista m ² /m. 0.059 Jx 0.00 cm ⁴ Wx 0.00 cm ³ Jy 0.00 cm ⁴ Wy 0.00 cm ³	 Tavola B 03
CP 355010 Profilo compensatore Butterfly Peso kg/ml. 0.550 Perimetro mm. 272 Super. in vista m ² /m. 0.089 Jx 0.00 cm ⁴ Wx 0.00 cm ³ Jy 00.00 cm ⁴ Wy 0.00 cm ³	 Tavola B 06	PS45.910 Telaio Peso kg/ml. 1.090 Perimetro mm. 346 Super. in vista m ² /m. 0.074 Jx 0.00 cm ⁴ Wx 0.00 cm ³ Jy 0.00 cm ⁴ Wy 0.00 cm ³	 Tavola B 03
RX450.2981 Ovalina 50 x 10 Peso kg/ml. 0.377 Perimetro mm. 112 Super. in vista m ² /m. 0.112 Jx 0.23 cm ⁴ Wx 0.47 cm ³ Jy 3.24 cm ⁴ Wy 1.62 cm ³	 Tavola B 04	RX450.5484 Lamella mm.71 Peso kg/ml. 0.552 Perimetro mm. 191 Super. in vista m ² /m. 0.180 Jx 0.72 cm ⁴ Wx 0.65 cm ³ Jy 9.56 cm ⁴ Wy 2.62 cm ³	 Tavola B 04
RX450.13173 Lamella mm.71 Peso kg/ml. 0.570 Perimetro mm. 195 Super. in vista m ² /m. 0.180 Jx 0.72 cm ⁴ Wx 0.65 cm ³ Jy 9.56 cm ⁴ Wy 2.62 cm ³	 Tavola B 04	RX450.5485 Compensatore lamella 71 mm Peso kg/ml. 0.424 Perimetro mm. 212 Super. in vista m ² /m. 0.105 Jx 4.40 cm ⁴ Wx 1.42 cm ³ Jy 0.36 cm ⁴ Wy 0.53 cm ³	 Tavola B 04
RX450.13178 Adattatore per compensatore Peso kg/ml. 0.307 Perimetro mm. 165 Super. in vista m ² /m. 0.023 Jx 0.22 cm ⁴ Wx 0.28 cm ³ Jy 1.63 cm ⁴ Wy 0.93 cm ³	 Tavola B 04	RX450.8694 Zoccolo riportato Peso kg/ml. 0.444 Perimetro mm. 142 Super. in vista m ² /m. 0.063 Jx 1.31 cm ⁴ Wx 1.04 cm ³ Jy 1.90 cm ⁴ Wy 1.17 cm ³	 Tavola B 03
RX450.2592 Profilo porta-spazzolino Peso kg/ml. 0.238 Perimetro mm. 139 Super. in vista m ² /m. 0.035 Jx 0.01 cm ⁴ Wx 0.03 cm ³ Jy 0.94 cm ⁴ Wy 0.51 cm ³	 Tavola B 05	RX450.8698 Riporto centrale Peso kg/ml. 0.585 Perimetro mm. 166 Super. in vista m ² /m. 0.114 Jx 2.89 cm ⁴ Wx 1.80 cm ³ Jy 6.90 cm ⁴ Wy 2.72 cm ³	 Tavola B 03
PS45.908 Anta Peso kg/ml. 1.185 Perimetro mm. 380 Super. in vista m ² /m. 0.090 Jx 0.00 cm ⁴ Wx 0.00 cm ³ Jy 0.00 cm ⁴ Wy 0.00 cm ³	 Tavola B 03	RX450.70258 Lamella Firenze Peso kg/ml. 0.458 Perimetro mm. 157 Super. in vista m ² /m. 0.156 Jx 0.00 cm ⁴ Wx 0.00 cm ³ Jy 00.00 cm ⁴ Wy 0.00 cm ³	 Tavola B 04

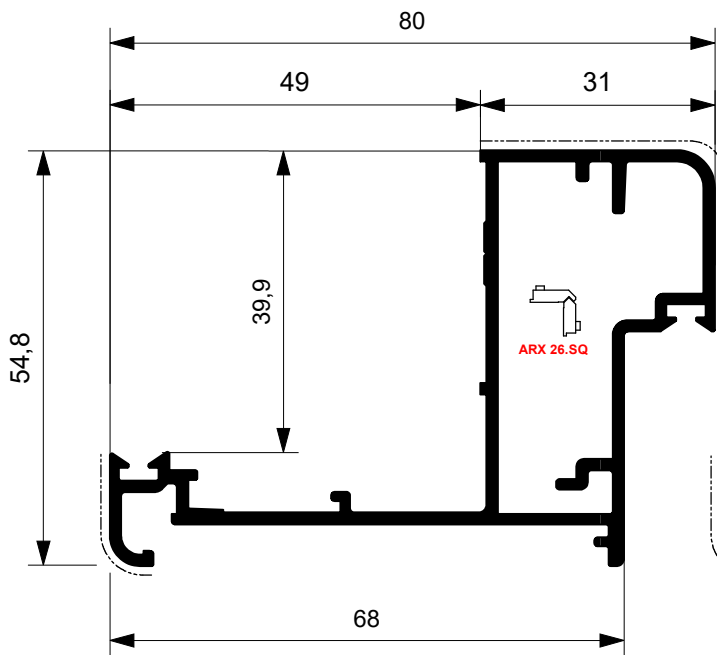

ELENCO PROFILATI

RX450.8419			Tavola B 04
Compensatore lamella 71 mm			
Peso	kg/ml. 0.447		
Perimetro	mm. 216		
Super. in vista	m ² /m. 0.105		
Jx 4.40 cm ⁴ Wx 1.42 cm ³ Jy 0.36 cm ⁴ Wy 0.53 cm ³			
RX450.8709			Tavola B 05
Porta lamella			
Peso	kg/ml. 0.275		
Perimetro	mm. 157		
Super. in vista	m ² /m. 0.025		
Jx 0.26 cm ⁴ Wx 0.34 cm ³ Jy 1.29 cm ⁴ Wy 0.70 cm ³			
RX450.9392			Tavola B 05
Lamella persiana			
Peso	kg/ml. 0.413		
Perimetro	mm. 180		
Super. in vista	m ² /m. 0.124		
Jx 0.22 cm ⁴ Wx 0.32 cm ³ Jy 5.26 cm ⁴ Wy 1.75 cm ³			
RX450.9621			Tavola B 03
Fascia-zoccolo			
Peso	kg/ml. 1.234		
Perimetro	mm. 321		
Super. in vista	m ² /m. 0.190		
Jx 36.20 cm ⁴ Wx 7.87 cm ³ Jy 12.04 cm ⁴ Wy 6.02 cm ³			
RX450.9627			Tavola B 05
Compensatore lamella			
Peso	kg/ml. 0.431		
Perimetro	mm. 165		
Super. in vista	m ² /m. 0.044		
Jx 1.97 cm ⁴ Wx 1.00 cm ³ Jy 1.84 cm ⁴ Wy 0.76 cm ³			
SA 25987		 <small>RX450.70258 Agni 0-028 --- mm. 156</small>	Tavola B 08
Doga 110 x 23.5			
Peso	kg/ml. 0.662		
Perimetro	mm. 326		
Super. in vista	m ² /m. 0.220		
Jx 0.00 cm ⁴ Wx 0.00 cm ³ Jy 00.00 cm ⁴ Wy 0.00 cm ³			

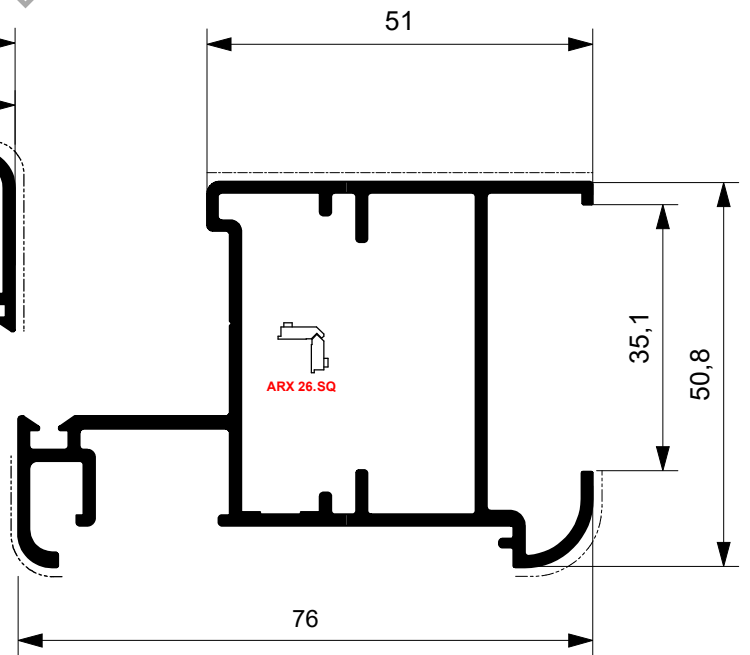

PS45.910

Kg/ml 1.090
--- mm. 74



PS45.908

Kg/ml 1.185
--- mm. 90

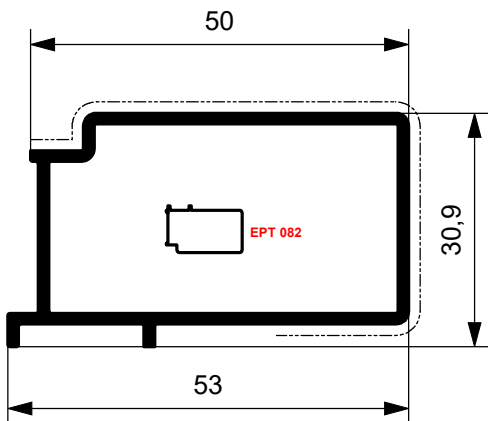

RX450.5671

Kg/ml 0,596

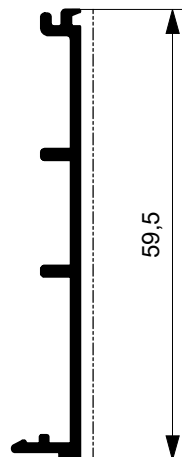

PS45.909

Kg/ml 0.291
--- mm. 59

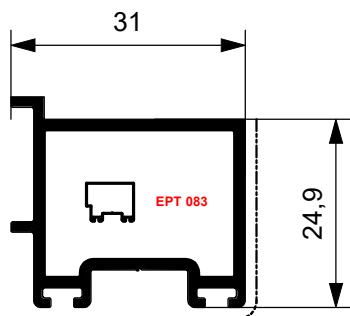

RX450.5796

Kg/ml 0,454

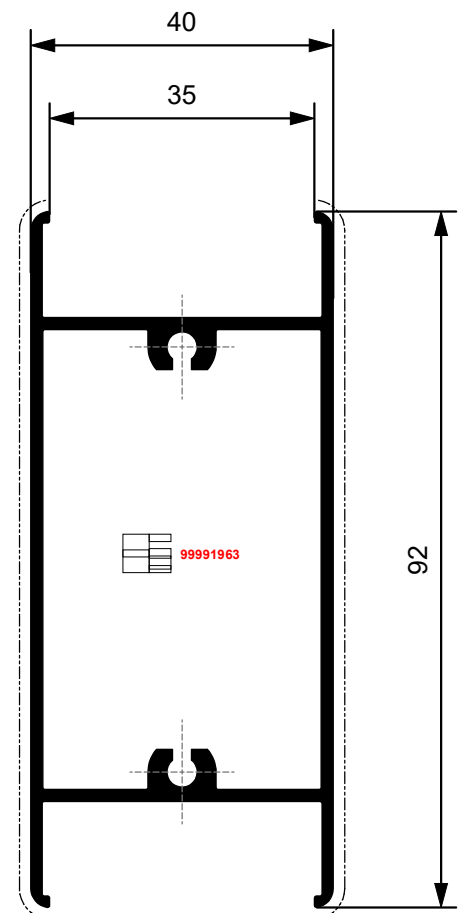

RX450.9621

Kg/ml 1,234
--- mm. 190

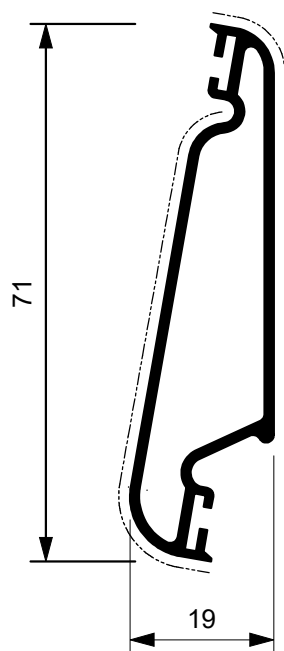

RX450.13173

Kg/ml 0,570
--- mm. 180

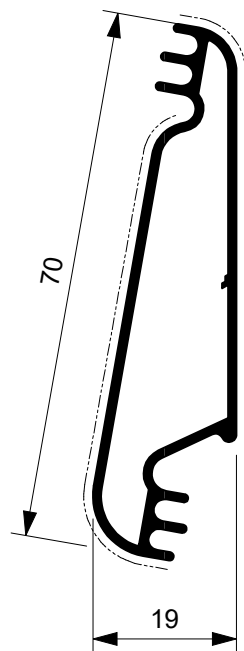

RX450.5484

Kg/ml 0,552
--- mm. 180

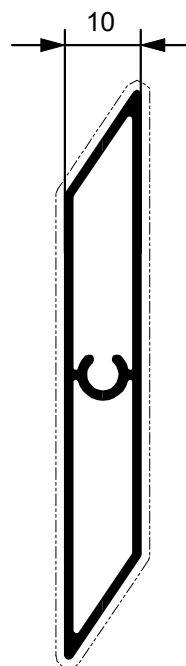

RX450.70258

Kg/ml 0,458
--- mm. 156

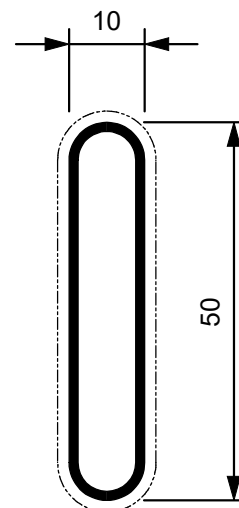

RX450.2981

Kg/ml 0,377
--- mm. 112

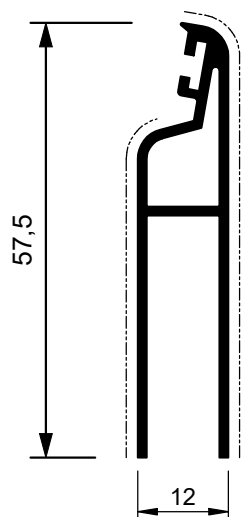

RX450.8419

Kg/ml 0,447
--- mm. 105

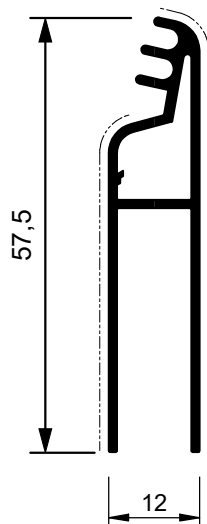

RX450.5485

Kg/ml 0,424
--- mm. 105

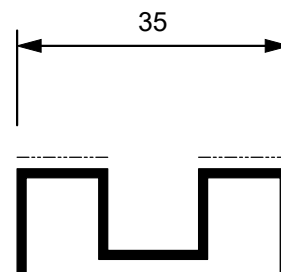

RX450.13178

Kg/ml 0,447
--- mm. 23

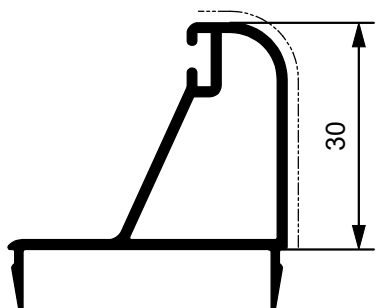

RX450.9627

Kg/ml 0,431

--- mm. 44

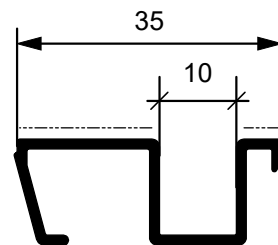

RX450.8709

Kg/ml 0,275

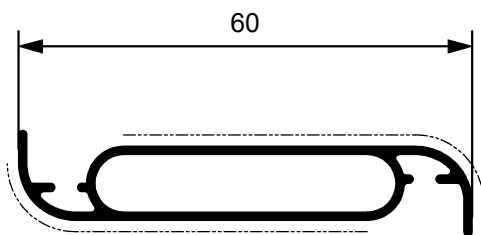

RX450.9392

Kg/ml 0,413

--- mm. 124

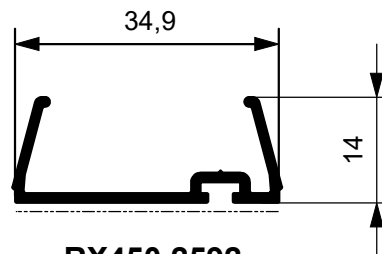

RX450.2592

Kg/ml 0,238

--- mm. 35



Profili Butterfly
per lamella ovale 50 x 10

Asole ovali 50 x 10

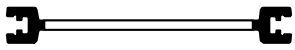

Asole ovali 50 x 10

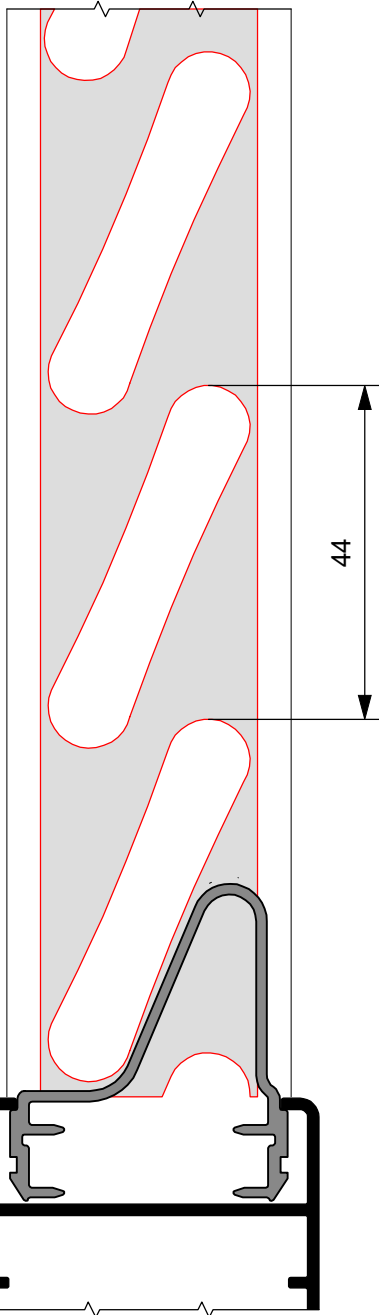

Compensazione minima

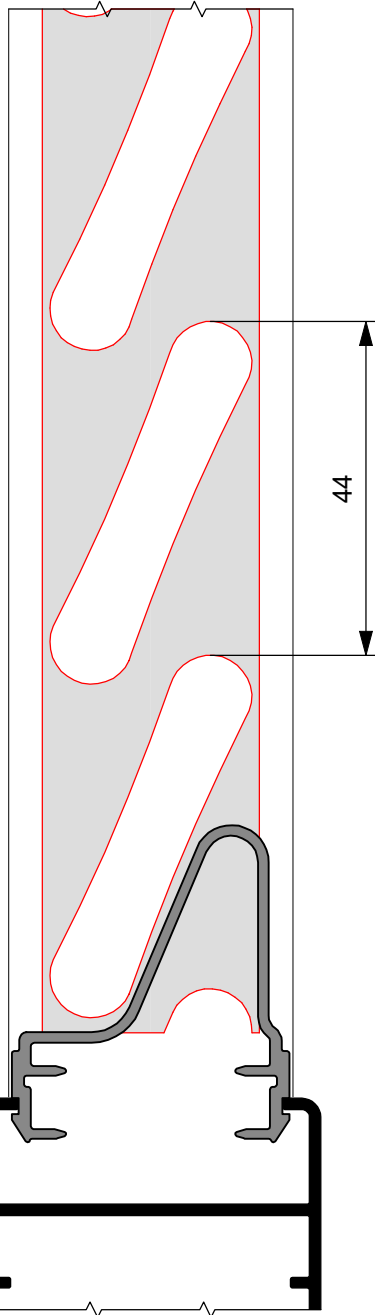

Compensazione massima

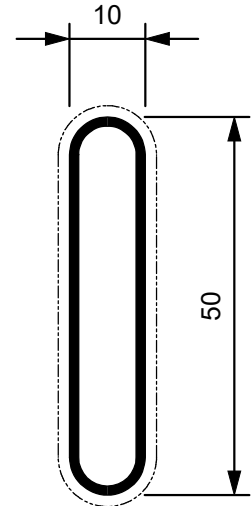

RX450.2981

Kg/ml 0,377

--- mm. 112

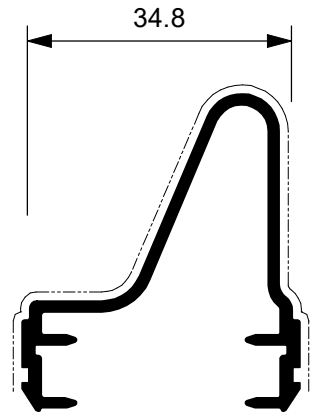

CP 355010

Kg/ml 0,550

--- mm. 89

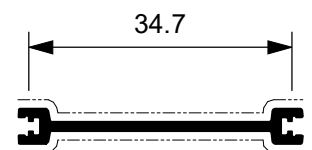

BT 355010

Kg/ml 0,164

--- mm. 70

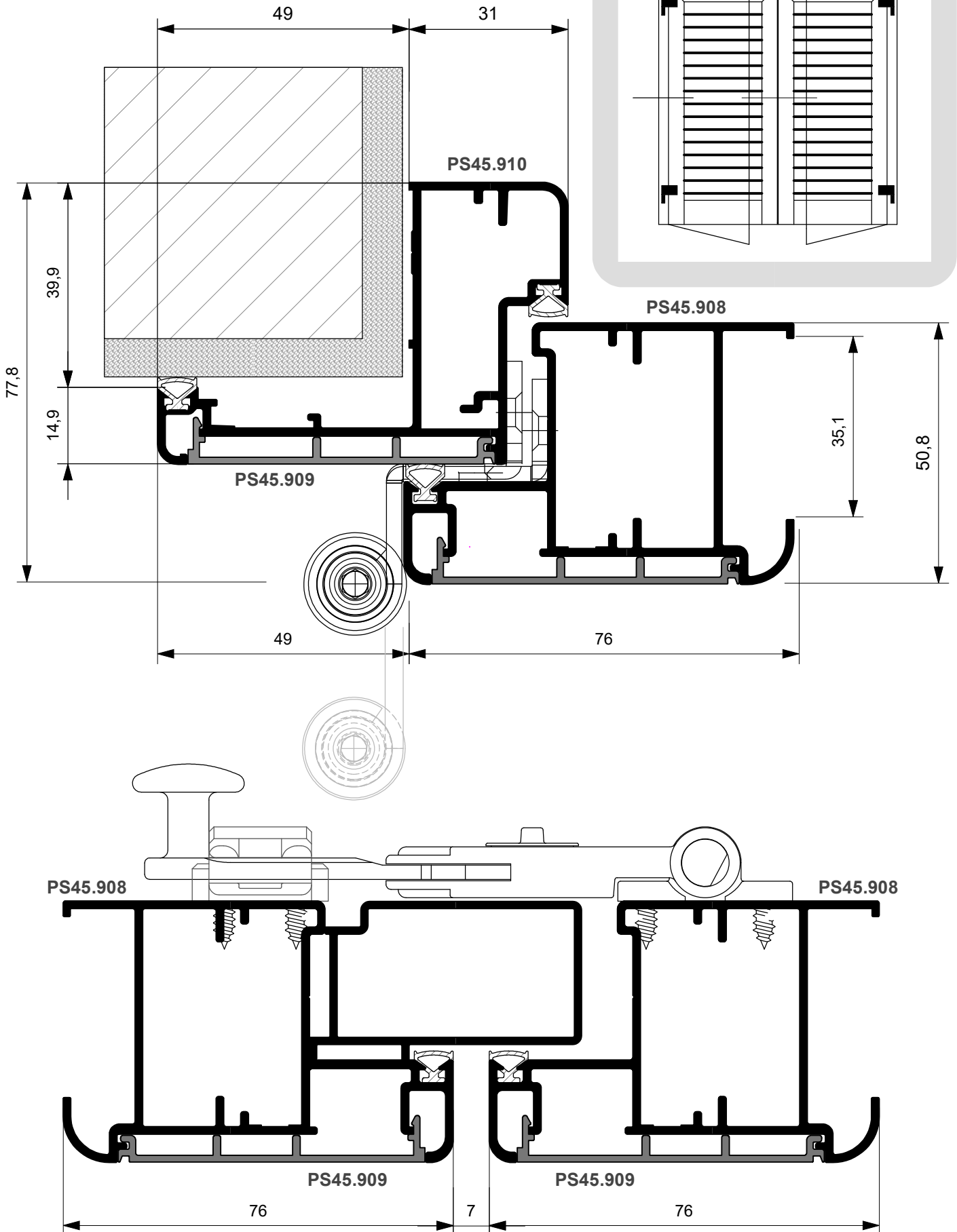

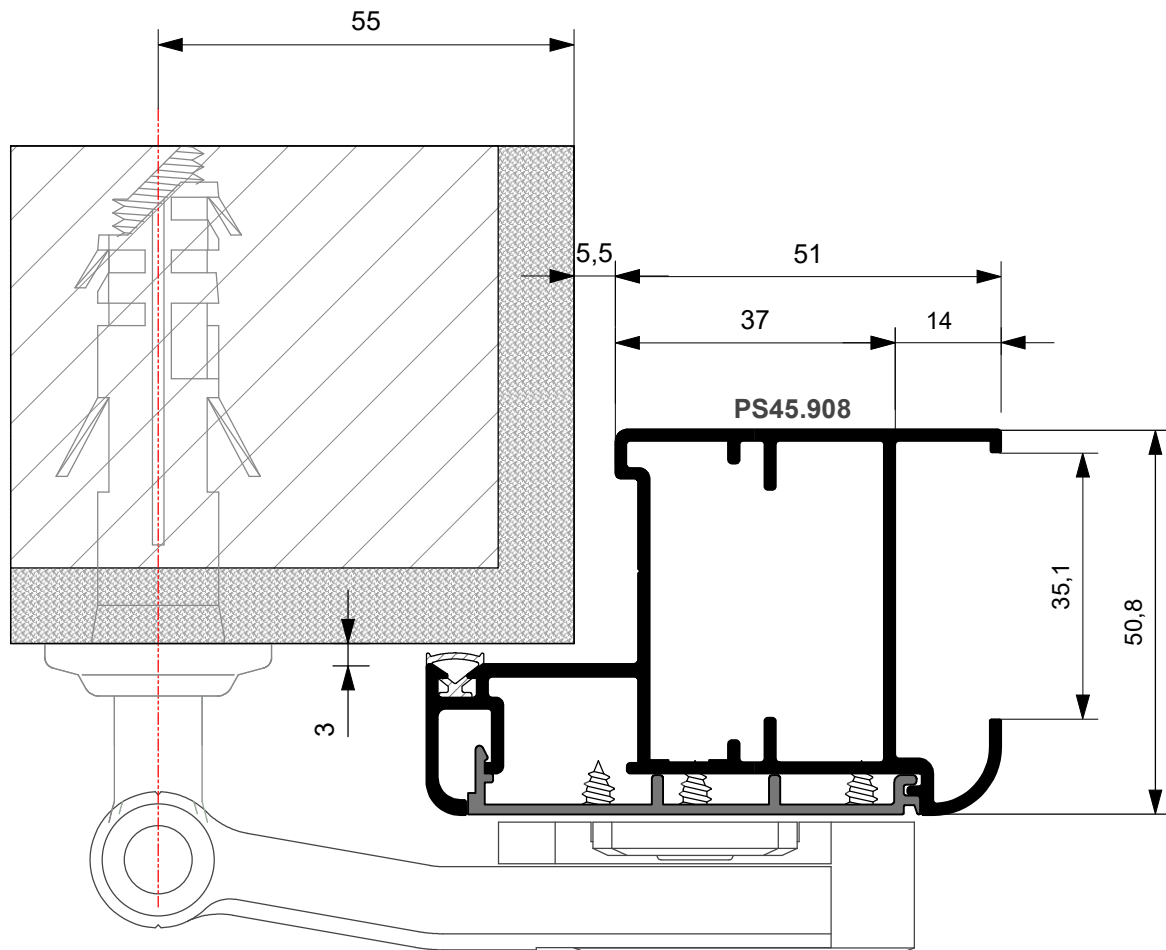
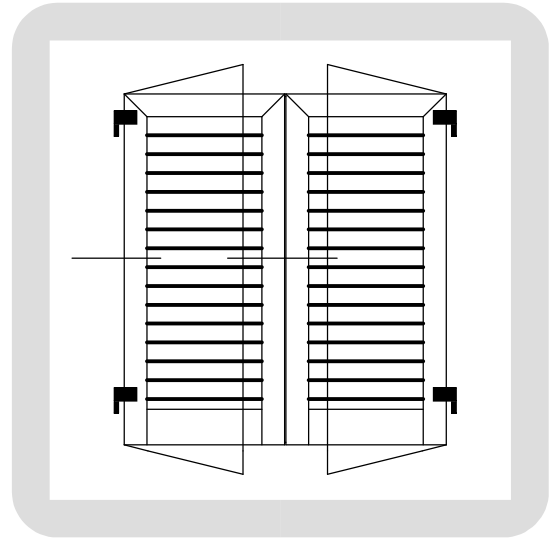

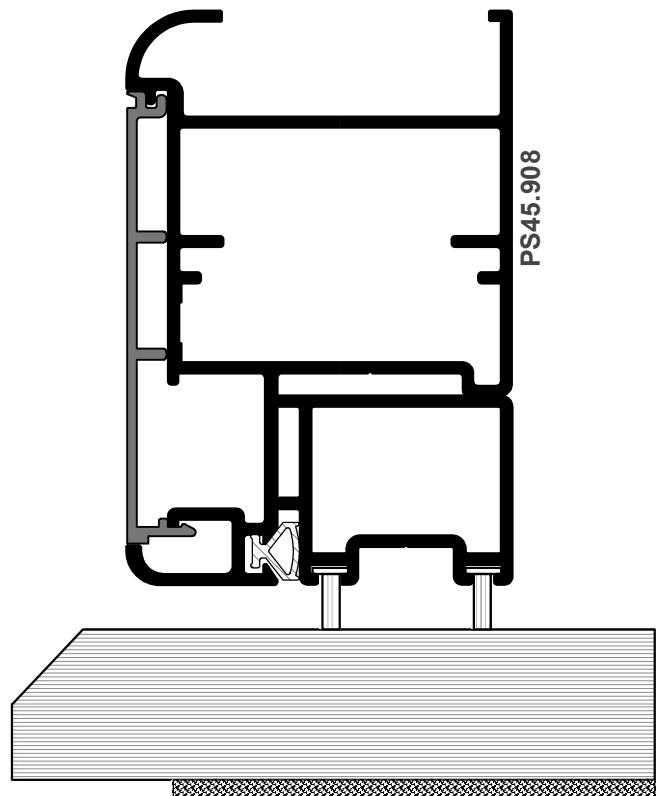
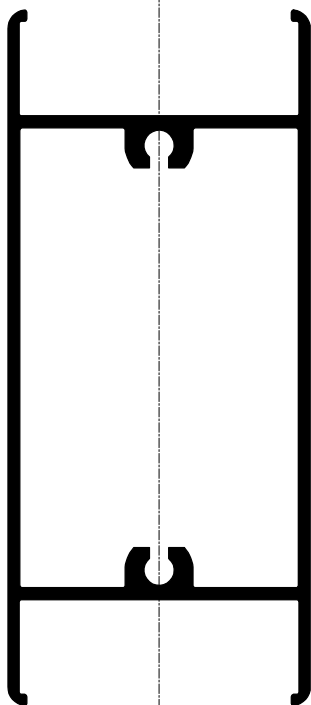
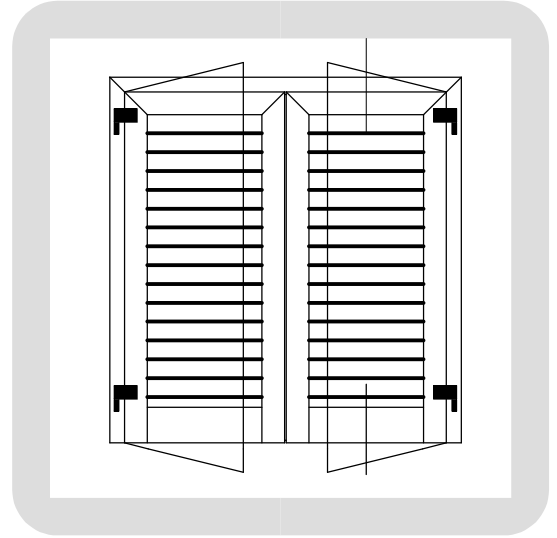
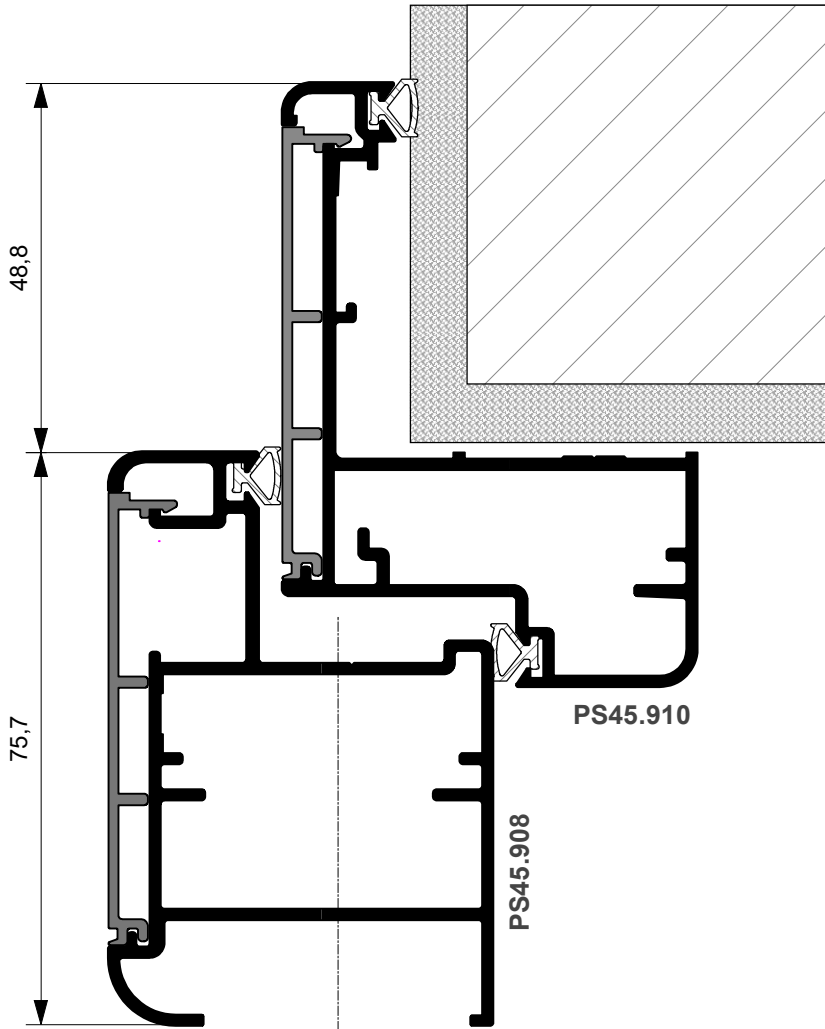

PAM SYSTEM S.r.l.

S.S. 230 - Fornace Crocicchio
13030 Formigliana (VC)
Tel. 0161 858811 - Fax 0161 858800
www.pamsystemsrl.com - info@pamsystemsrl.com

ALQ System

Via Colano, 9/A 12/K
16162 Genova Bolzaneto
Tel. +39 010 7491941 - Fax +39 010 7450155
www.alqsystem.it - info@alqsystem.it

PAESANI GROUP

Paesani S.r.l.

Via del Grano, 260
47822 Santarcangelo di Romagna (Rn)
Tel. +39 0541 748511 - Fax +39 0541 741208
www.paesani.com - info@paesani.com

Magazzino Nord

Via Luigi Bonati, 21
29017 Fiorenzuola d'Arda (PC)
Tel. +39 0523 943228 - Fax +39 0523 941127
magazzinonord@paesani.com

ALUK GROUP Centro di Firenze Piani

della Rugginosa, 203/206
55066 Reggello (FI)
Tel. 055 8662351/352 - Fax 055 8662065

DIVA S.a.s. di GPD s.r.l. & C.

Via Po, 25 - Z. I. Sambuceto
66020 San Giovanni Teatino (CH)
Tel. 085 4405210 - Fax 085 4405207
www.camel-diva.com - info@camel-diva.com

EUROALL S.r.l.

Strada Comunale della Mola Saracena, 23
00065 Fiano Romano (RM)
Tel. 0765 455228/61 - Fax 0765 455317
www.euroall srl.it - info@euroall srl.it

PROFILATI UMBRIA S.r.l.

Via Dei Tigli, 35
06083 Bastia Umbra (PG)
Tel. 075 8012385-075 8010328 - Fax 075 8012386
profilatiumbria@virgilio.it

TSL ALLUMINIO S.r.l.

Via delle Industrie, 12 00030 San Cesareo (Roma)
Tel. 06 2251591 (Ric. Aut.) - Fax 06 2280693
www.tslalluminio.it - info@tslluminio.it

ALLCAR SERVICE S.r.l.

Via Acuto, 120 - 00131 Roma
Tel. 06 4130626 (Ric. Aut.) - Fax 06 4130367
allcarservice@mclink.it

ALLUCOM S.r.l.

Via Vecchia Barletta 237
Z. Ind. - 76123 Andria (BT)
Tel. 0883 592213 - Fax 0883 552386
www.allucom.com - info@allucom.com

ALLUCOM S.r.l.

Via Zippitelli, 28/B - 70123 (BA)
Tel. 0805058608 - Fax 0805058607
www.allucom.com - info@allucom.com

CARUSO S.r.l.

Z.I. Contrada Le Macere
86019 Vinchiaturo (CB)
Tel. 0874 340024 - Fax 0874 340025
carusosrl1@libero.it

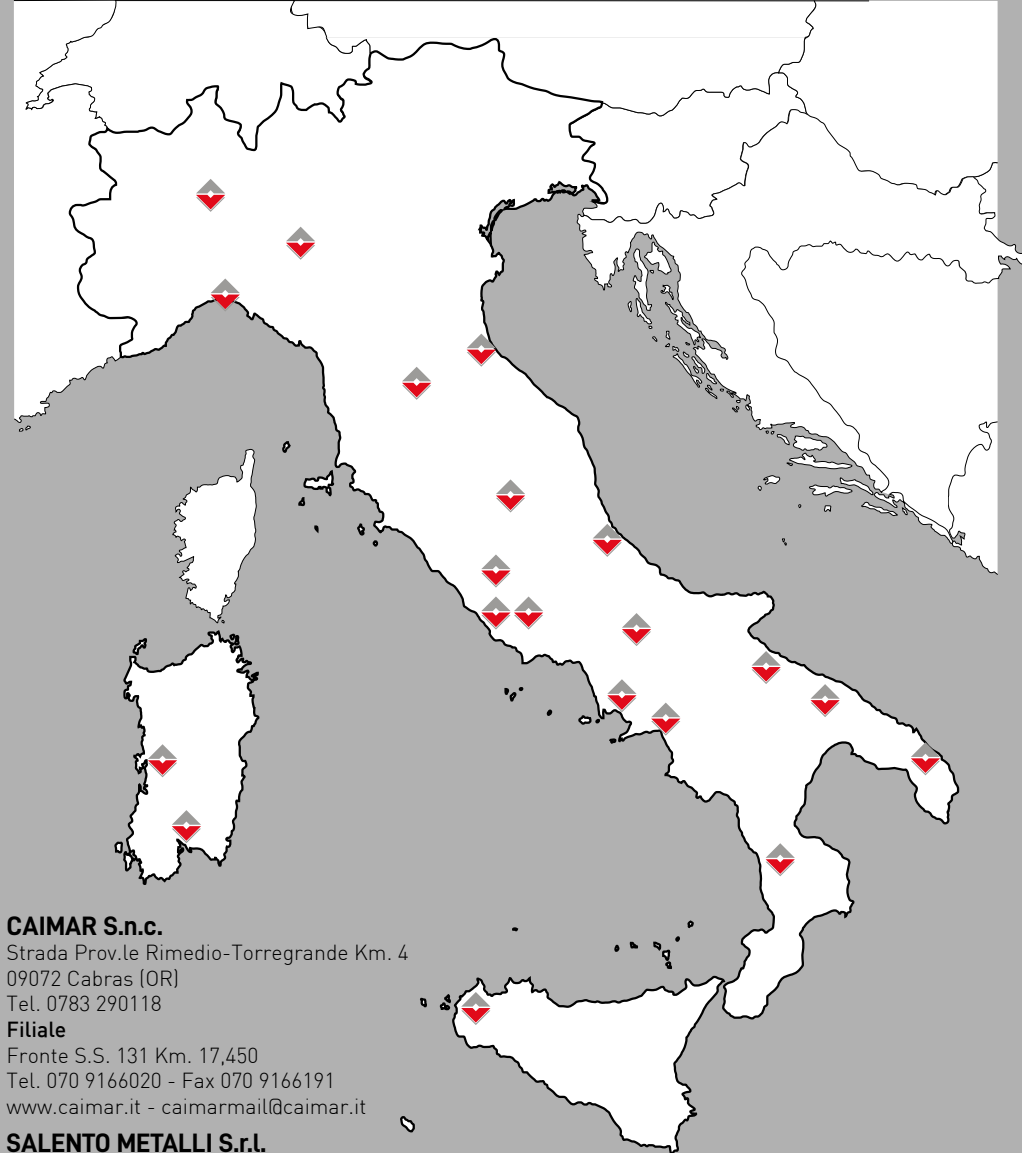

CAIMAR S.n.c.

Strada Prov.le Rimedio-Torregrande Km. 4
09072 Cabras (OR)
Tel. 0783 290118

Filiale

Fronte S.S. 131 Km. 17,450
Tel. 070 9166020 - Fax 070 9166191
www.caimar.it - caimarmail@caimar.it

SALENTO METALLI S.r.l.

Via Federico II, 13 - Zona PIP
73020 Cavallino (LE)
Tel. 0832 614576 - Fax 0832 614635
www.salentometalli.it - info@salentometalli.it

MIDA ALLUMINIO S.r.l.

Via Piano del Principe, 36
80047 San Giuseppe Vesuviano (NA)
Tel. 081 5297373 - Fax 081 8284449
www.midaalluminiogroup.it - info@gruppomida.it

MIDA ALLUMINIO S.r.l.

Loc. Terzerie - Z. Ind.
80061 Ogliastro Cilento (SA)
Tel. 0974 833233 - Fax 0974 844724
www.midaalluminiogroup.it - info@midaalluminiogroup.it

ITALBACOLOR S.r.l.

C.da Valle S. Maria
87024 Fuscaldo (CS)
Tel. 0982 618025 - Fax 0982 720235
www.italbacolor.it - commerciale@italbacolor.it

COMAS S.r.l.

Via Porta Palermo, 84
91011 Alcamo (TP)
Tel. 0924 507050 - Fax 0924 507051
www.comasgroup.it - info@comasgroup.it



www.twinsystems.it info@twinsystems.it

Consorzio **TWIN SYSTEMS**

Via delle Macere, 20 00060 Formello (Roma)
Tel./Fax 06 23260298

